



McIntosh Laboratory, Inc. 2 Chambers Street Binghamton, New York 13903-2699 Phone: 607-723-3512 www.mcintoshlabs.com

RoomPerfect

Manufactured under license from Lyngdorf Audio A/S. ROOMPERFECT is a registered trademark and the ROOMPERFECT logo is a trademark of Lyngdorf Audio A/S. (C) Lyngdorf Audio A/S 2009.

MEN220
Room Correction System
Owner's Manual



The lightning flash with arrowhead, within an equilateral triangle, is intended to alert the user to the presence of uninsulated “dangerous voltage” within the product’s enclosure that may be of sufficient magnitude to constitute a risk of electric shock to persons.

WARNING - TO REDUCE RISK OF FIRE OR ELECTRICAL SHOCK, DO NOT EXPOSE THIS EQUIPMENT TO RAIN OR MOISTURE.



AVIS RISQUE DE CHOC ELECTRIQUE - NE PAS OUVRIR.

NO USER-SERVICEABLE PARTS INSIDE. REFER SERVICING TO QUALIFIED PERSONNEL.

The exclamation point within an equilateral triangle is intended to alert the user to the presence of important operating and maintenance (servicing) instructions in the literature accompanying the appliance.

To prevent the risk of electric shock, do not remove cover or back. No user-serviceable parts inside.

IMPORTANT SAFETY INSTRUCTIONS!

PLEASE READ THEM BEFORE OPERATING THIS EQUIPMENT.

1. Read these instructions.
2. Keep these instructions.
3. Heed all warnings.
4. Follow all instructions.
5. Do not use this apparatus near water.
6. Clean only with a dry cloth.
7. Do not block any ventilation openings. Install in accordance with the manufacturer’s instructions.
8. Do not install near any heat sources such as radiators, heat registers, stoves, or other apparatus (including amplifiers) that produce heat.
9. Do not defeat the safety purpose of the polarized or grounding-type plug. A polarized plug has two blades with one wider than the other. A grounding type plug has two blades and a

third grounding prong. The wide blade or the third prong are provided for your safety. If the provided plug does not fit into your outlet, consult an electrician for replacement of the obsolete outlet.

10. Protect the power cord from being walked on or pinched particularly at plugs, convenience receptacles, and the point where they exit from the apparatus.
11. Only use attachments/accessories specified by the manufacturer.
12. Use only with the cart, stand, tripod, bracket, or table specified by the manufacturer, or sold with the apparatus. When a cart is used, use caution when moving the cart/apparatus combination to avoid injury from tip-over.
13. Unplug this apparatus during lightning storms or when unused for long periods of time.
14. Refer all servicing to qualified service personnel. Servicing is required when the apparatus has been damaged in any way, such as power-



supply cord or plug is damaged, liquid has been spilled or objects have fallen into the apparatus, the apparatus has been exposed to rain or moisture, does not operate normally, or has been dropped.

15. Do not expose this equipment to dripping or splashing and ensure that no objects filled with liquids, such as vases, are placed on the equipment.
16. To completely disconnect this equipment from the a.c. mains, disconnect the power supply cord plug from the a.c. receptacle.
17. The mains plug of the power supply cord shall remain readily operable.
18. Do not expose batteries to excessive heat such as sunshine, fire or the like.
19. Connect mains power supply cord only to a mains socket outlet with a protective earthing connection.

Thank You

Your decision to own this McIntosh MEN220 Room Correction System ranks you at the very top among discriminating music listeners. You now have “The Best.” The McIntosh dedication to “Quality,” is assurance that you will receive many years of musical enjoyment from this unit.

Please take a short time to read the information in this manual. We want you to be as familiar as possible with all the features and functions of your new McIntosh.

Please Take A Moment

The serial number, purchase date and McIntosh Dealer name are important to you for possible insurance claim or future service. The spaces below have been provided for you to record that information:

Serial Number: _____

Purchase Date: _____

Dealer Name: _____

Technical Assistance

If at any time you have questions about your McIntosh product, contact your McIntosh Dealer who is familiar with your McIntosh equipment and any other brands that may be part of your system. If you or your Dealer wish additional help concerning a suspected problem, you can receive technical assistance for all McIntosh products at:

McIntosh Laboratory, Inc.
2 Chambers Street
Binghamton, New York 13903
Phone: 607-723-3512
Fax: 607-724-0549

Customer Service

If it is determined that your McIntosh product is in need of repair, you can return it to your Dealer. You can also return it to the McIntosh Laboratory Service Department. For assistance on factory repair return procedure, contact the McIntosh Service Department at:

McIntosh Laboratory, Inc.
2 Chambers Street
Binghamton, New York 13903
Phone: 607-723-3515
Fax: 607-723-1917

General Information



1. For additional connection information, refer to the owner’s manual(s) for any component(s) connected to the MEN220 Room Correction System.
2. The Main AC Power going to the MEN220 and any other McIntosh Component(s) should not be applied until all the system components are connected together. Failure to do so could result in malfunctioning of some or all of the system’s normal operations. When the MEN220 and other McIntosh Components are in their Standby Power Off Mode, the Microprocessor’s Circuitry inside each component is active and communication is occurring between them.
3. Sound Intensity is measured in units called Decibels and “dB” is the abbreviation.
4. When discarding the unit, comply with local rules or regulations. Batteries should never be thrown away or incinerated but disposed of in accordance with the local regulations concerning battery disposal. 
5. For additional information on the MEN220 and other McIntosh Products please visit the McIntosh Web Site at www.mcintoshlabs.com. 



Table of Contents

Safety Instructions	2
Thank You and Please Take a Moment.....	3
Technical Assistance and Customer Service	3
General Information	3
Table of Contents	4
Connector and Cable Information	4
Introduction.....	5
Performance Features	5
Dimensions	6
Installation	7
Connections:	
Rear Panel Connections.....	8
How to Connect the MEN220	9-12
Remote Control:	
Remote Control Push-buttons.....	14
How to use the Remote Control.....	15
Front Panel:	
Front Panel Displays, Controls and Push-buttons....	16
Setup:	
How to Operate the Setup Mode	17
Default Settings.....	17
Input Connection Settings	18
System Connection Settings	18
Output Settings	19
Advanced Settings	22
RoomPerfect	24
Operation:	
How to Operate the MEN220	28-29
Additional Information:	
Specifications.....	30
Packing Instruction.....	31

Connector and Cable Information

XLR Connectors

Below is the Pin configuration for the XLR Balanced Output Connectors on the MEN220. Refer to the diagrams for connections:

- PIN 1: Shield/Ground
- PIN 2: + Signal
- PIN 3: - Signal

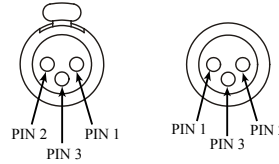

Power Control Connectors

The MEN220 Power Control Input/Output Jacks receive/send Power On/Off Signals when connected to other McIntosh Components. A 1/8 inch stereo mini phone plug is used for connection to the Power Control Input/Output on the MEN220.

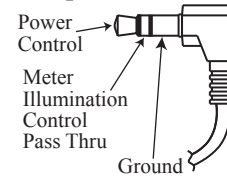

*Note: The Data and Power Control Connecting Cable is available from the McIntosh Parts Department: **Data and Power Control Cable Part No. 170-202** Six foot, shielded 2 conductor, with 1/8 inch stereo mini phone plugs on each end.*

Data and IR Input Port Connectors

The MEN220 Data In Port receives Remote Control Signals. A 1/8 inch stereo mini phone plug is used for connection. The IR Port also use a 1/8 inch stereo mini phone plug and allow the connection of other brand IR Receivers to the MEN220.

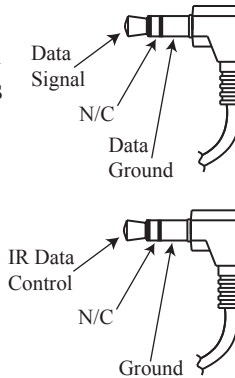

RS232 DB9 Connector Pin Layout

- | | |
|-------------------|--------|
| 1. N/C | 6. N/C |
| 2. Data Out (TXD) | 7. N/C |
| 3. Data In (RXD) | 8. N/C |
| 4. N/C | 9. N/C |
| 5. Gnd. | |

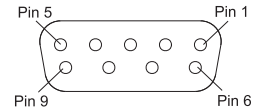

Microphone XLR Connectors

Below is the Pin configuration for the Microphone Connector on the MEN220. Refer to the diagram for connections:

- PIN 1: Shield/Ground
- PIN 2: Signal
- PIN 3: +8.9VDC

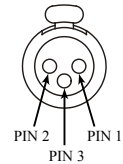

Introduction

The MEN220 Room Correction System is an elegant instrument for restoring superb sound reproduction to your audio system by measuring and correcting for less than ideal room acoustics. The MEN220 uses the latest in technology to quickly restore proper musical balance in a minimum amount of time. The McIntosh Sound is “The Sound of the Music Itself.”

Performance Features

• Room Correction

The MEN220 uses the latest in technology to restore musical balance to audio systems located in rooms with less than ideal acoustics, whether the system is two channel or multichannel.

• Focus and Global Settings

The MEN220 provides for measurement and correction for up to eight specific listening locations (Focus Positions) in a room. It also measures additional locations in the room and produces a Global Room Correction for listening anywhere in the room.

• Electronic Crossover

The advanced two way electronic crossover built into the MEN220 provides the best way for adding true bi-amplification to your audio system.

• Variable Crossover Settings

The variable crossover in the MEN220 allows the crossover frequency to be set from 10Hz to 20,000Hz. Select from three available crossover slope rates for both the Butterworth or Linkwitz-Riley Filter Types.

• Listening Equalization Curves

The MEN220 has six preset Equalization Curves to choose from when listening to various type of music.

• Precision Measurement Microphone

The MEN220 is supplied with an Omnidirectional Electret Condenser Microphone to accurately measure the Loudspeaker performance together with Room Acoustics. The microphone has high resistance to vibrations, flat frequency response and a high signal-to-noise ratio. It is “phantom power” from the MEN220 via the balanced cable.

• Professional Microphone Stand with Boom

The MEN220 is supplied with a professional type adjustable height microphone stand. The Boom Adapter allows for easy placement of the Precision Microphone for precise Focus Measurements.

• Multiple Outputs

The MEN220 has both Unbalanced and Balanced Outputs of which permit long cable lengths without a loss in sound quality.

• Multi-Function Front Panel Display

The Front Panel Information Display indicates various setup and operational functions.

• Power Control and Full Function Remote Control

The Power Control Input connection provides convenient Turn-On/Off of the MEN220 when connected to a McIntosh System. The Remote Control push-buttons provide complete control of the MEN220 operating functions.

• Special Power Supply

The Power Supply has both a special large Toroidal Wound Power Transformer and Multiple Regulators to ensure stable noise free operation even though the power line varies.

• Extruded Side Panels

The sides of the MEN220 are extruded aluminum panels with a bead blast textured surface and a black anodized finish.

• Fiber Optic Solid State Front Panel Illumination

The Illumination of the Glass Front Panel is accomplished by the combination of custom designed Fiber Optic Light Diffusers and extra long life Light Emitting Diodes (LEDs). This provides even Front Panel Illumination and is designed to ensure the pristine beauty of the MEN220 will be retained for many years.



Dimensions

The following dimensions can assist in determining the best location for your MEN220.

Front View of the MEN220

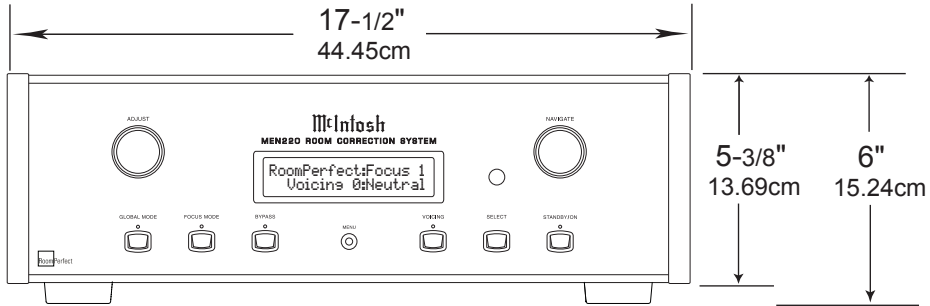

Rear View of the MEN220

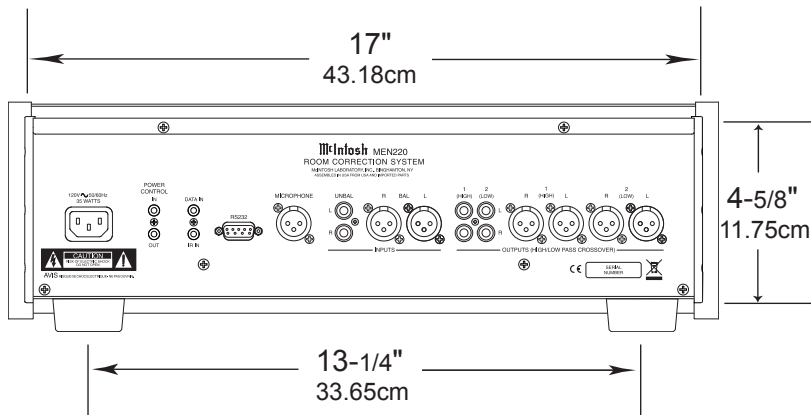

Side View of the MEN220

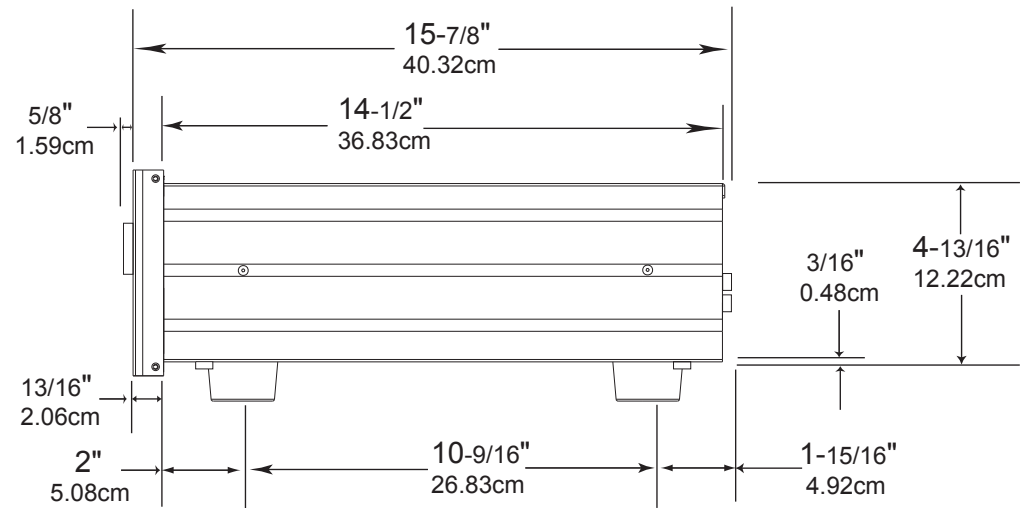

Installation

The MEN220 can be placed upright on a table or shelf, standing on its four feet. It also can be custom installed in a piece of furniture or cabinet of your choice. The four feet may be removed from the bottom of the MEN220 when it is custom installed as outlined below. The four feet together with the mounting screws should be retained for possible future use if the MEN220 is removed from the custom installation and used free standing. The required panel cutout, ventilation cutout and unit dimensions are shown.

Always provide adequate ventilation for your MEN220. Cool operation ensures the longest possible operating life for any electronic instrument. Do not install the MEN220 directly above a heat generating component such as a high powered amplifier. If all the components are installed in a single cabinet, a quiet running ventilation fan can be a definite asset in maintaining all the system components at the coolest possible operating temperature.

When the MEN220 is placed free-standing on a flat surface, allow at least 2 inches (5.08cm) above the top, 2 inches (5.08cm) below the bottom and 2 inches (5.08cm) on each side of the MEN220, so airflow is not obstructed. Allow 19-1/2 inches (49.53cm) depth behind the front panel. Allow 1-7/16 inch (3.66cm) in front of the mounting panel for knob clearance.

A custom cabinet installation should provide the minimum spacing dimensions for cool operation. Allow at least 2 inches (5.08cm) above the top, 2 inches (5.08cm) below the bottom and 2 inches (5.08cm) on each side of the MEN220, so airflow is not obstructed. The Custom Cabinet should be open backed and at least 12 inches (30.48cm) away from any surface such as a wall. Be sure to cut out a ventilation hole in the mounting shelf according to the dimensions in the drawing. Allow 1-7/16 inch (3.66cm) in front of the mounting panel for knob clearance.

MEN220 Front Panel Custom Cabinet Cutout

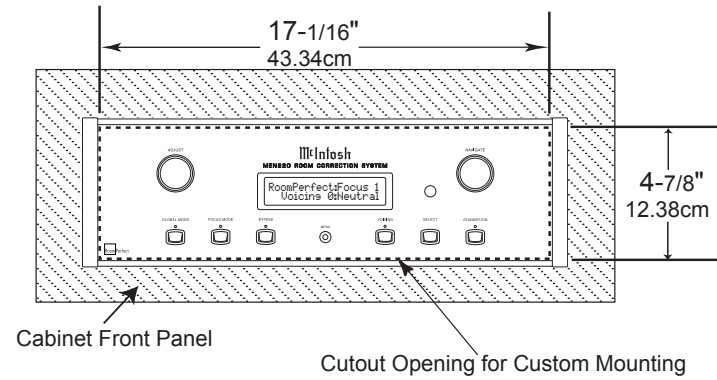

MEN220 Side View in Custom Cabinet

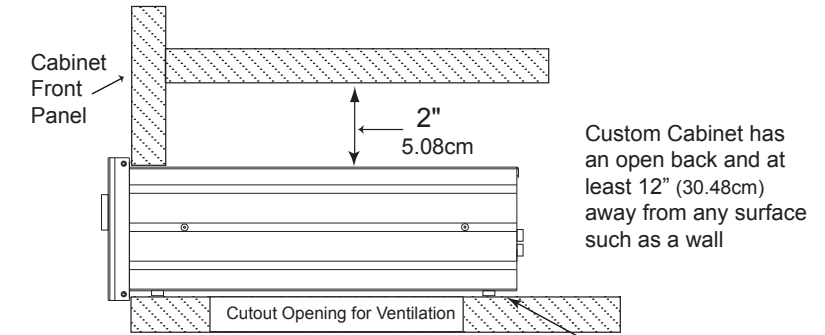

MEN220 Bottom View in Custom Cabinet

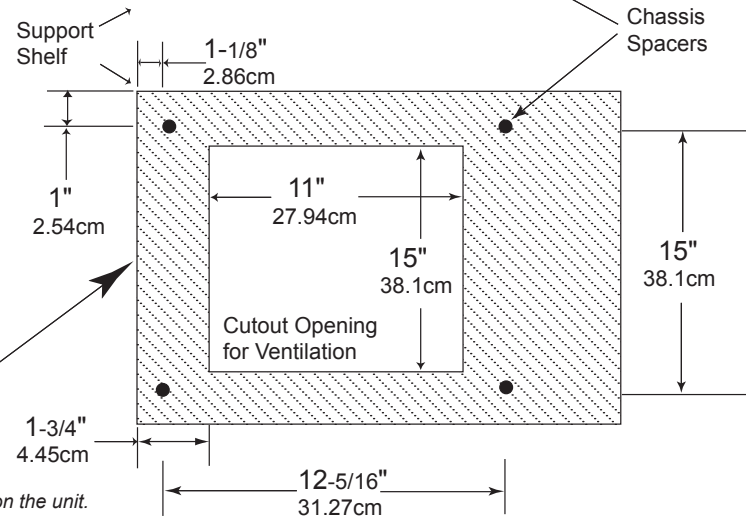

Note: Center the cutout Horizontally on the unit.
For purposes of clarity, the above illustration is not drawn to scale.

POWER CONTROL IN receives signals from a McIntosh component (5-15 Volts ON, 0 Volts OFF). POWER CONTROL OUT sends out a (12 Volts ON) signal to another McIntosh Component when the MEN220 is On

RS232 connector for communications with an external control device

Unbalanced OUTPUT 1 (HIGH) supplies Full Range or High Frequency audio signals to a Power Amplifier

DATA IN receives operating data from a McIntosh Preamplifier or Control Center

UNBALANCED AUDIO INPUTS receive audio signals from a Preamplifier or an A/V Control Center

Balanced OUTPUT 1 (HIGH) supplies Full Range or High Frequency audio signals to a Power Amplifier

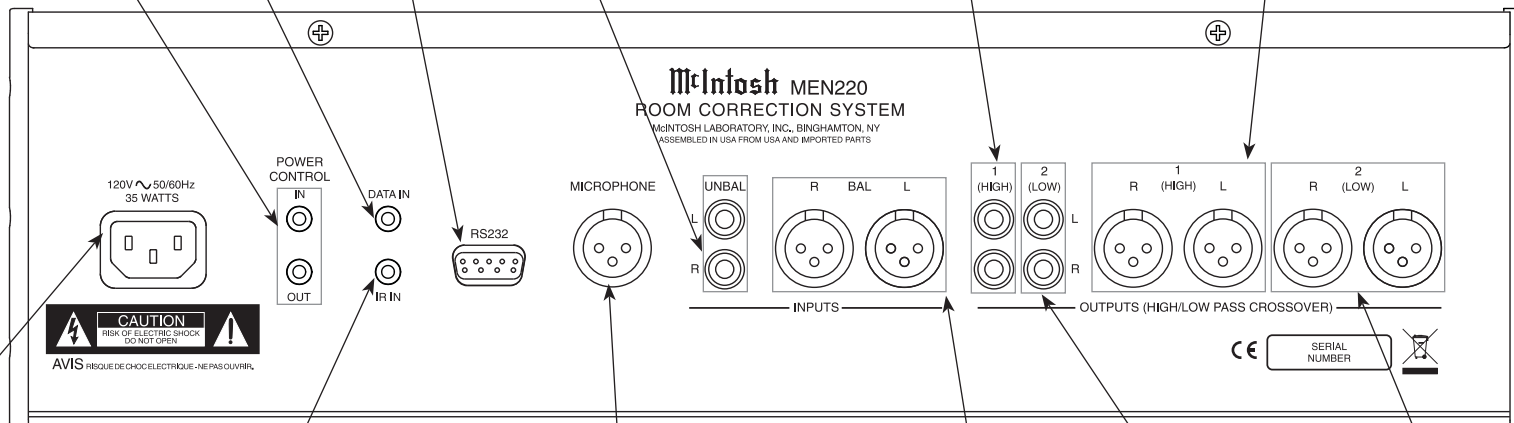

Connect the MEN220 power cord to a live AC outlet. Refer to information on the back panel of your MEN220 to determine the correct voltage for your unit

IR Input for connecting an IR Receiver

Connect the MEN220 Calibrated Microphone with the supplied cable

BALANCED AUDIO INPUTS receive audio signals from a Preamplifier or an A/V Control Center

Unbalanced OUTPUT 2 (LOW) supplies Full Range or Low Frequency audio signals to a Power Amplifier

Balanced OUTPUT 2 (LOW) supplies Full Range or Low Frequency audio signals to a Power Amplifier

How to Connect the MEN220

The MEN220 has the ability to be remotely switched On/Off from a Preamplifier or A/V Control Center via the Power Control connection. The Data Port Connection allows for the remote operation of basic functions using the MEN220 Remote Control. With an external sensor connected to the MEN220, remote control operation is possible from another room and/or when the MEN220 is located in a cabinet with the doors closed.

The connection instructions below, together with the MEN220 Connection Diagram “Mc1A” located on the separate folded sheet, is an example of a typical audio system. Your system may vary from this, however the actual components would be connected in a similar manner. For additional information refer to “Connector and Cable Information” on page 4.

Power Control Connections:

1. Connect a Control Cable from the Preamplifier or A/V Control Center Power Control MAIN Jack to the POWER CONTROL IN Jack on the McIntosh MEN220.
2. Connect a Control Cable from the MEN220 POWER CONTROL OUT Jack to the Power Amplifier 1 Power Control In Jack.
3. Connect a Control Cable from the Power Amplifier 1 Power Control Out Jack to the Power Amplifier 2 Power Control In Jack.
4. Connect any additional components in a similar manner, as outlined in steps 2 thru 3.

Data Control Connections:

5. Connect a Control Cable from the Preamplifier or A/V Control Center SUM Data Port Jack to the McIntosh MEN220 DATA IN Jack.

Note: If the Preamplifier or A/V Control Center doesn't have a SUM Data Port Jack, contact McIntosh for additional assistance.

Sensor Connections:

6. Connect an external Sensor to the McIntosh MEN220 IR IN Jack.

Audio Connections:

7. Connect Balanced Cables from the McIntosh MEN220 BALANCED AUDIO INPUT Connectors to the Preamplifier or A/V Control Center Balanced Output Jacks.

Notes: 1. The Unbalanced Outputs on the MEN220 may be used instead of the Balanced Connections.

2. By default the Unbalanced Inputs are the active Connections. To use the Balanced Inputs instead, it is first necessary to change the default setting using the MEN220 Setup Mode. Refer to pages 17 and 18.

8. Connect a Balanced Cable from the MEN220 BALANCED AUDIO OUTPUT (1) R Connector to the Power Amplifier 1 Balanced Input Connector.

Note: The Unbalanced and Balanced Output Connections are both active and may be used at the same time.

9. Connect a Balanced Cable from the MEN220 BALANCED AUDIO OUTPUT (1) L Connector to the Power Amplifier 2 Balanced Input Connector.

Loudspeaker Connections:

10. Refer to the Owner's Manuals supplied with the Power Amplifier and Loudspeakers for connection information.

AC Power Cords Connections:

11. Connect the McIntosh MEN220 AC Power Cord to a live AC outlet.





How to Connect the MEN220 in a Processor Loop

The MEN220 may be connected to the Listen Processor Loop on a McIntosh Preamplifier or A/V Control Center, instead of being connected between the Preamplifier Output and Power Amplifier Input.

The MEN220 has the ability to be remotely switched On/Off from a Preamplifier or A/V Control Center via the Power Control connection.

The Data Port Connection allow for the remote operation of basic functions using the MEN220 Remote Control. With an external sensor connected to the MEN220, remote control operation is possible from another room and/or when the MEN220 is located in a cabinet with the doors closed.

The connection instructions below, together with the MEN220 Connection Diagram located on the separate folded sheet “Mc1B” is an example of a typical audio system. Your system may vary from this, however the actual components would be connected in a similar manner. For additional information refer to “Connector and Cable Information” on page 4.

Power Control Connections:

1. Connect a Control Cable from the Preamplifier or A/V Control Center Power Control MAIN Jack to the POWER CONTROL IN Jack on the McIntosh MEN220.
2. Connect a Control Cable from the MEN220 POWER CONTROL OUT Jack to the Power Amplifier 1 Power Control In Jack.
3. Connect a Control Cable from Power Amplifier 1 Power Control Out Jack to the Power Amplifier 2 Power Control In Jack.
4. Connect any additional components in a similar manner, as outlined in steps 2 thru 3.

Data Control Connections:

5. Connect a Control Cable from the Preamplifier or

A/V Control Center SUM Data Port Jack to the McIntosh MEN220 DATA IN Jack.

Note: If the Preamplifier or A/V Control Center doesn't have a SUM Data Port Jack, contact McIntosh for additional assistance.

Sensor Connections:

6. Connect an external Sensor to the McIntosh MEN220 IR IN Jack.

Audio Connections:

7. Connect Audio Cables from the McIntosh MEN220 UNBALANCED AUDIO INPUT Connectors to the Preamplifier or A/V Control Center Processor (Listen) TO Output Jacks.
8. Connect Audio Cables from the MEN220 UNBALANCED AUDIO OUTPUT 1 (High) R Connector to the Preamplifier or A/V Control Center Processor (Listen) Right Channel FROM Input Jacks.
9. Connect Audio Cables from the MEN220 UNBALANCED AUDIO OUTPUT 1 (High) L Connector to the Preamplifier or A/V Control Center Processor (Listen) Right Channel FROM Input Jacks.
10. Connect a Balanced Cable from the Preamplifier or A/V Control Center Right Channel Main Output to Power Amplifier 1 Balanced Input.
11. Connect a Balanced Cable from the Preamplifier or A/V Control Center Left Channel Main Output to Power Amplifier 2 Balanced Input.

Loudspeaker Connections:

12. Refer to the Owner's Manuals supplied with the Power Amplifier and Loudspeakers for connection information.

AC Power Cords Connections:

13. Connect the McIntosh MEN220 AC Power Cord to a live AC outlet.

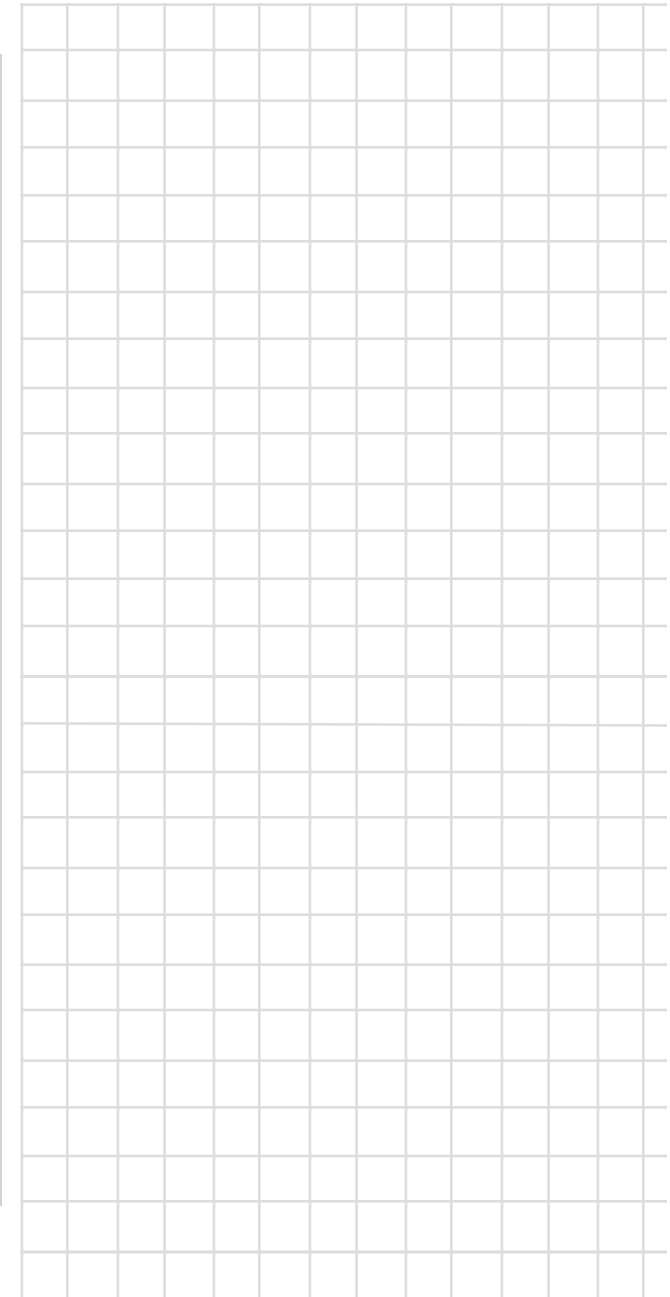

How to Connect the MEN220 with Crossover

The MEN220 has a built-in Electronic Crossover Network with an adjustable Crossover Frequency. It also has the ability to be remotely switched On/Off from a McIntosh Preamplifier or A/V Control Center via the Power Control connection. The Data Port Connection allow for the remote operation of basic functions using the MEN220 Remote Control. With an external sensor connected to the MEN220, remote control operation is possible from another room and/or when the MEN220 is located in a cabinet with the doors closed.

The connection instructions below, together with the MEN220 Connection Diagram located on the separate folded sheet “**Mc2A**” is an example of a typical audio system. Your system may vary from this, however the actual components would be connected in a similar manner. For additional information refer to “Connector and Cable Information” on page 4.

Power Control Connections:

1. Connect a Control Cable from the Preamplifier or A/V Control Center Power Control MAIN Jack to the POWER CONTROL IN Jack on the McIntosh MEN220.
2. Connect a Control Cable from the MEN220 POWER CONTROL OUT Jack to the Power Amplifier 3 Power Control In Jack.
3. Connect a Control Cable from Power Amplifier 3 Power Control Out Jack to the Power Amplifier 1 Power Control In Jack.
4. Connect a Control Cable from Power Amplifier 1 Power Control Out Jack to the Power Amplifier 2 Power Control In Jack.
5. Connect any additional components in a similar manner, as outlined in steps 2 thru 3.

Data Control Connections:

6. Connect a Control Cable from the Preamplifier or A/V Control Center SUM Data Port Jack to the McIntosh MEN220 DATA IN Jack.

Note: If the Preamplifier or A/V Control Center doesn't have a SUM Data Port Jack, contact McIntosh for additional assistance.

Sensor Connections:

7. Connect an external Sensor to the McIntosh MEN220 IR IN Jack.

Audio Connections:

8. Connect Balanced Cables from the McIntosh MEN220 BALANCED AUDIO INPUT Connectors to the Preamplifier or A/V Control Center Balanced Output Jacks.

Notes: 1. The Unbalanced Outputs on the MEN220 may be used instead of the Balanced Connections.

2. By default the Unbalanced Inputs are the active Connections. To use the Balanced Inputs instead, it is first necessary to change the default setting using the MEN220 Setup Mode. Refer to pages 17 and 18.

9. Connect a Balanced Cable from the MEN220 BALANCED AUDIO OUTPUT (1) (High Pass) R Connector to Power Amplifier 3 Balanced Input R Connector.

Note: The Unbalanced and Balanced Output Connections are both active and may be used at the same time.
10. Connect a Balanced Cable from the MEN220 BALANCED AUDIO OUTPUT (1) (High Pass) L Connector to Power Amplifier 3 Balanced Input L Connector.
11. Connect a Balanced Cable from the MEN220 BALANCED AUDIO OUTPUT (2) (Low Pass) R

Connector to Power Amplifier 3 Balanced Input Connector.

12. Connect a Balanced Cable from the MEN220 BALANCED AUDIO OUTPUT (2) (Low Pass) L Connector to Power Amplifier 2 Balanced Input Connector.

Loudspeaker Connections:

The following Loudspeaker Connection instructions are based on the Crossover Settings outlined in the Setup Section in this Owner's Manual. Refer to pages 19 and 20 for additional information.

13. Refer to the Owner's Manuals supplied with the Power Amplifier and Loudspeakers for information on connecting Power Amplifiers 1 and 2 to the Low Frequency Section of the Loudspeakers.

When the Electronic Crossover Circuitry in the MEN220 is active. It is important the sound coming from the Low Frequency Section of the Loudspeaker be in “Acoustical Phase” with the sound from the High Frequency Section of the Loudspeaker. The connections between Power Amplifier 3 and the High Frequency Section of the Loudspeakers need the electrical connection phase reversed at the Loudspeaker High Frequency Section Terminals. This reversed phase connection will achieve the correct “Acoustical Phase” from the Loudspeaker System.

14. Connect COM (- negative) terminal of Amplifier 3 to the + (positive) terminal of the High Frequency Section of the Loudspeaker. Then connect 8Ω (+ positive) terminal of Amplifier 3 to the - (negative) terminal of the High Frequency Section of the Loudspeaker.

AC Power Cords Connections:

15. Connect the McIntosh MEN220 AC Power Cord to a live AC outlet.



How to Connect the MEN220 with Subwoofer

The MEN220 can be used in a system with a Subwoofer via the built-in Electronic Crossover Network with an adjustable Crossover Frequency.

It also has the ability to be remotely switched On/Off from a McIntosh Preamplifier or A/V Control Center via the Power Control connection. The Data Port Connection allows for the remote operation of basic functions using the MEN220 Remote Control. With an external sensor connected to the MEN220, remote control operation is possible from another room and/or when the MEN220 is located in a cabinet with the doors closed.

The connection instructions below, together with the MEN220 Connection Diagram located on the separate folded sheet “**Mc2B**” is an example of a typical audio system using a Subwoofer. Your system may vary from this, however the actual components would be connected in a similar manner. For additional information refer to “Connector and Cable Information” on page 4.

Power Control Connections:

1. Connect a Control Cable from the Preamplifier or A/V Control Center Power Control MAIN Jack to the POWER CONTROL IN Jack on the McIntosh MEN220.
2. Connect a Control Cable from the MEN220 POWER CONTROL OUT Jack to the Power Amplifier 1 Power Control In Jack.
3. Connect a Control Cable from Power Amplifier 1 Power Control Out Jack to the Power Amplifier 2 Power Control In Jack.
4. Connect a Control Cable from Power Amplifier 2 Power Control Out Jack to the Subwoofer Power Control In Jack.

5. Connect any additional components in a similar manner, as outlined in steps 2 thru 3.

Data Control Connections:

6. Connect a Control Cable from the Preamplifier or A/V Control Center SUM Data Port Jack to the McIntosh MEN220 DATA IN Jack.

Note: If the Preamplifier or A/V Control Center doesn't have a SUM Data Port Jack, contact McIntosh for additional assistance.

Sensor Connections:

7. Connect an external Sensor to the McIntosh MEN220 IR IN Jack.

Audio Connections:

8. Connect Balanced Cables from the McIntosh MEN220 BALANCED AUDIO INPUT Connectors to the Preamplifier or A/V Control Center Balanced Output Jacks.

Notes: 1. The Unbalanced Outputs on the MEN220 may be used instead of the Balanced Connections.

2. By default the Unbalanced Inputs are the active Connections. To use the Balanced Inputs instead, it is first necessary to change the default setting using the MEN220 Setup Mode. Refer to pages 17 and 18.

9. Connect a Balanced Cable from the MEN220 Balanced AUDIO OUTPUT (1) (High Pass) R Connector to Power Amplifier 1 Balanced Input Connector.

Note: The Unbalanced and Balanced Output Connections are both active and may be used at the same time.

10. Connect a Balanced Cable from the MEN220 Balanced AUDIO OUTPUT (1) (High Pass) L

Connector to Power Amplifier 2 Balanced Input Connector.

11. Connect a Balanced Cable from the MEN220 Balanced AUDIO OUTPUT (2) (Low Pass) R (Mono) Connector to the Subwoofer Balanced Input Connector.

Loudspeaker Connections:

12. Refer to the Owner's Manuals supplied with the Power Amplifier and Loudspeakers for connection information.

AC Power Cords Connections:

13. Connect the McIntosh MEN220 AC Power Cord to a live AC outlet.

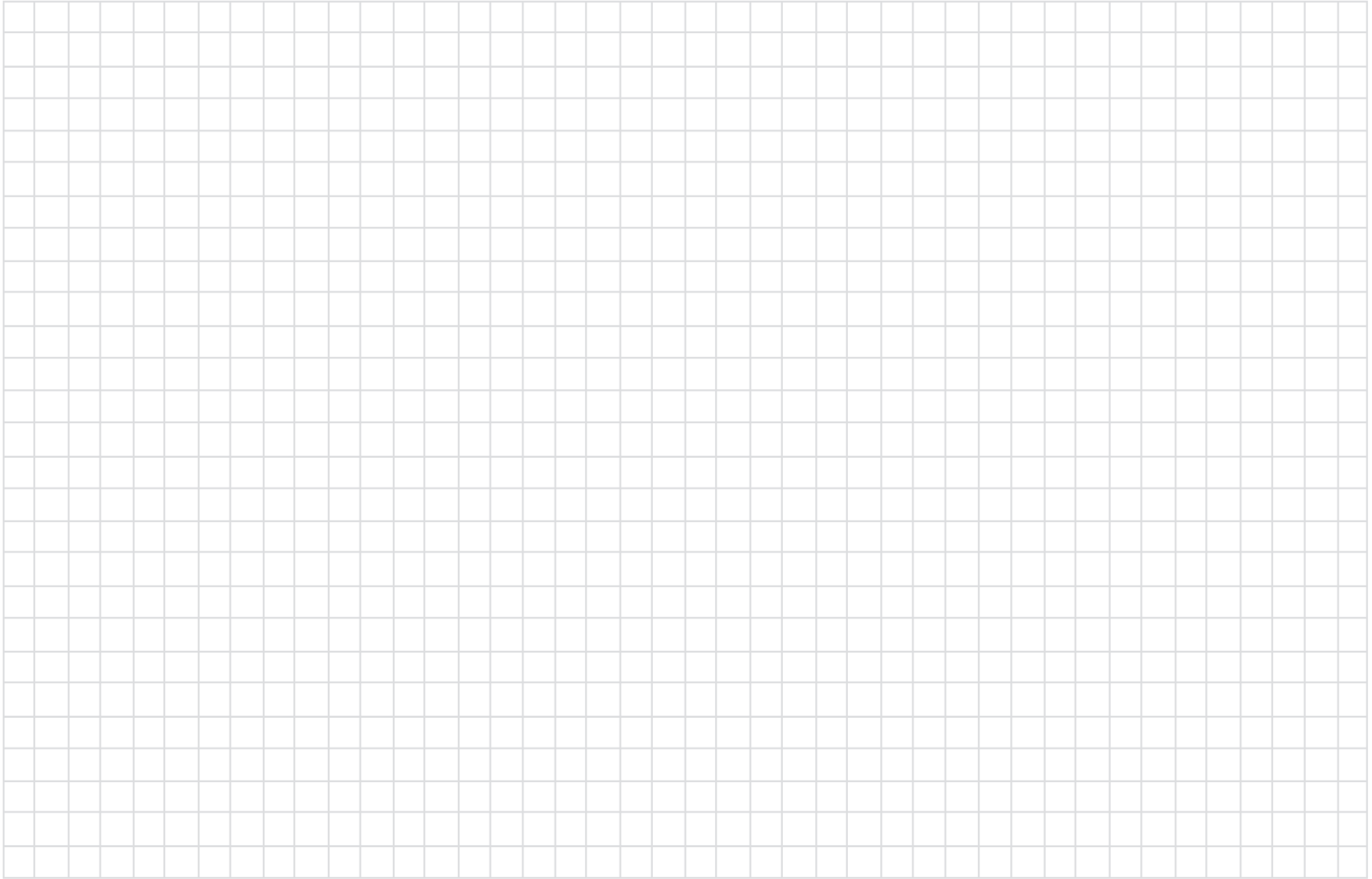

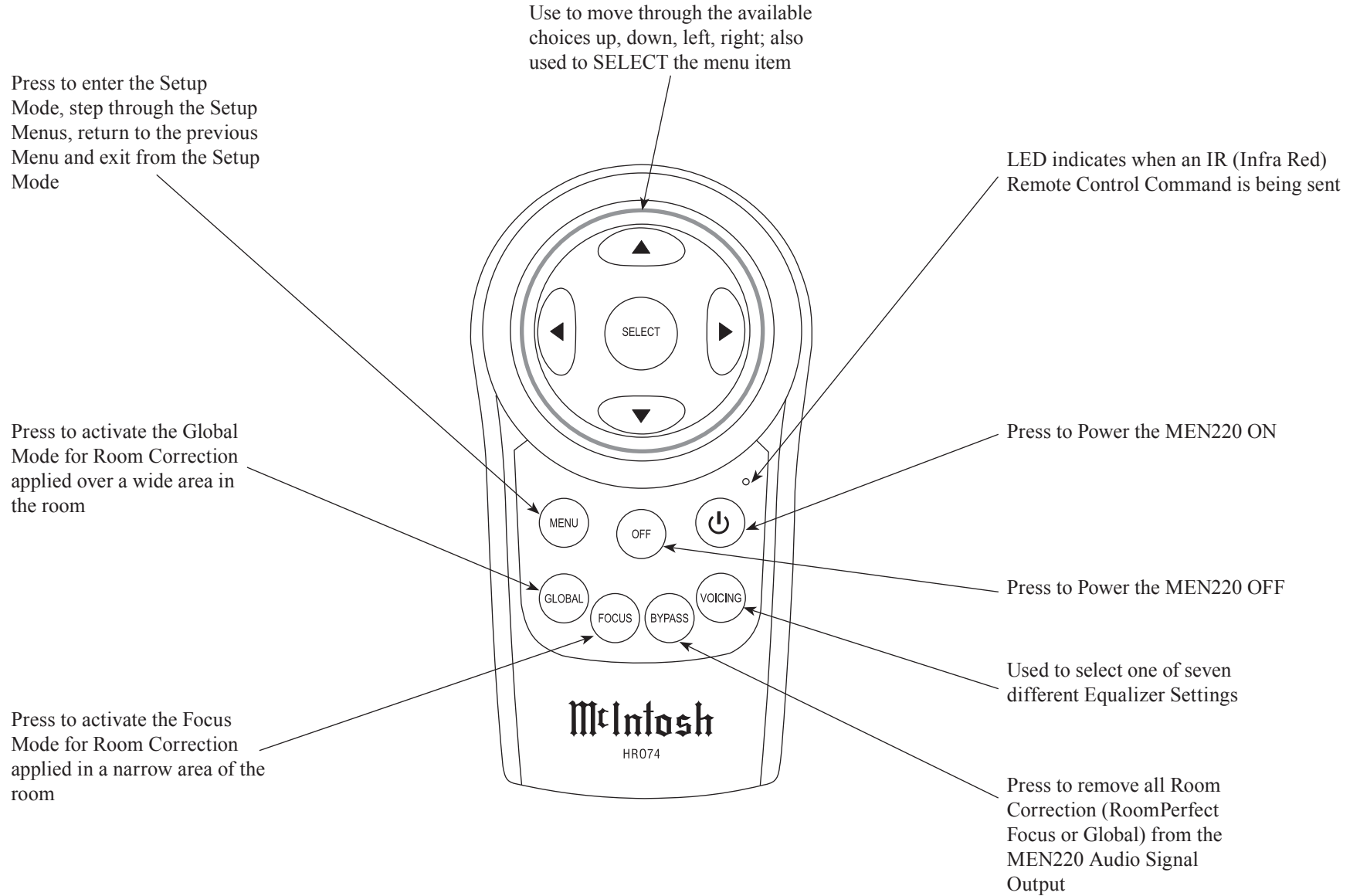

How to use the Remote Control

The Remote Control is capable of performing both basic Operating Functions and Setup Options for the MEN220 Room Correction System.

Notes: Refer to the “How to Operate” and “How to Operate Setup Mode” Sections of this manual for additional information using this Remote Control.

Power On

To Switch ON the MEN220 press the  (Power) Push-button on the Remote Control. The Front Panel Information Display top line will indicate “RoomPerfect: Muted” for approximately two seconds after turn on. Refer to figure 1.



Figure 1

Menu

Used to enter and exit from the SETUP Mode of operation. Refer to figure 2.



Figure 2

Global

Used to select a wide listening area of Room Correction in the MEN220 Audio Signal Output. Refer to figure 3.



Figure 3

Note: In order for the MEN220 to provide room correction, the Setup Mode “RoomPerfect” must be performed first.

Focus

Used to select a narrow listening area of Room Correction in the MEN220 Audio Signal Output. Refer to figure 4.



Figure 4

Note: In order for the MEN220 to provide room correction, the Setup Mode “RoomPerfect” must be performed first.

Bypass

When selected all Room Correction (RoomPerfect Focus or Global) is removed from the MEN220 Audio Signal Output. Refer to figure 5.

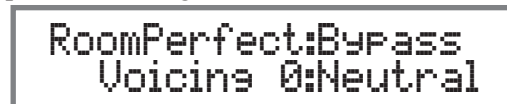

Figure 5

Note: Crossover Settings made in the Setup Mode are still active and effecting the MEN220 Audio Signal Outputs.

Voicing

After Room Correction (RoomPerfect Focus or Global) is active, some music recordings might require slight equalization modifications to restore musical balance. The MEN220 has built in six different variations to select from to restore musical balance. Refer to figures 6 and 7.

Note: The Voicing Mode may be used even when the RoomPerfect Mode is not active, however its effect may become less noticeable. Refer to figure 8.



Figure 6



Figure 7



Figure 8



ADJUST allows selection of various types of audio settings and is also used in the setup mode for various functions

FOCUS MODE Push-button with indicator, selects a narrow listening area of Room Correction

INFORMATION DISPLAY indicates various Operational Functions and Setup Mode Settings

SELECT Push-button selects the current choice as indicated on the Front Panel Information Display when in the Setup Mode

IR Sensor receives commands from a Remote Control

NAVIGATE is used in the setup mode for various functions

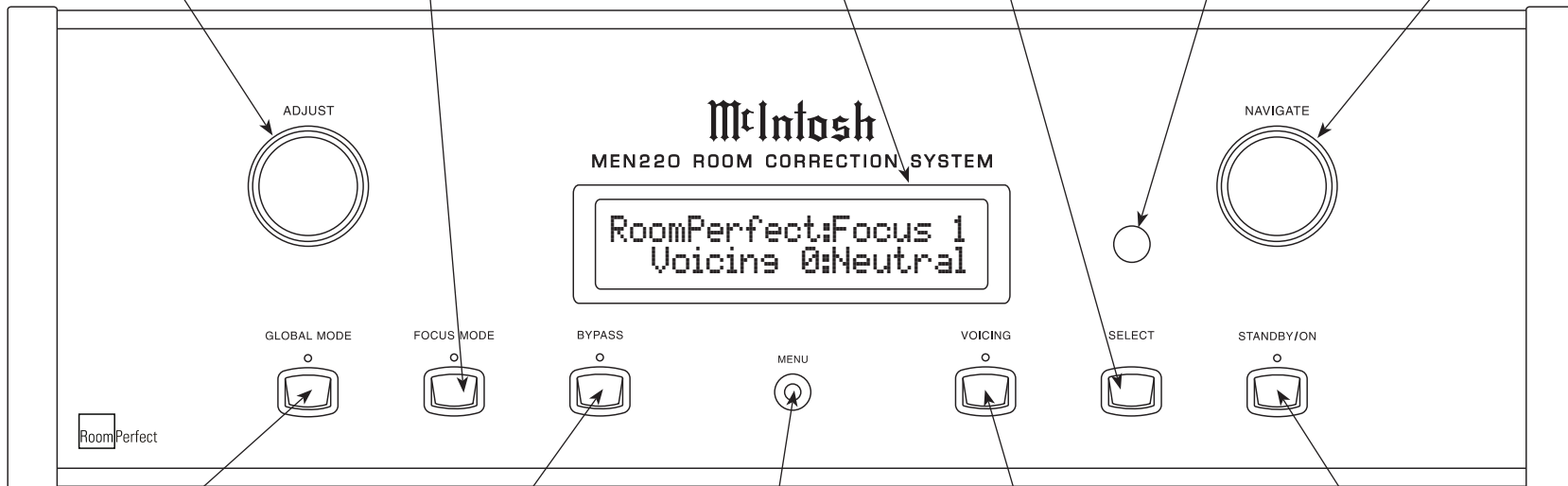

GLOBAL MODE Push-button with indicator, selects a wide listening area of Room Correction

BYPASS Push-button with indicator, removes all Room Correction (RoomPerfect Focus or Global) from the MEN220 Audio Signal Output

MENU Push-button is used to enter the Setup Mode, step through the Setup Menus, return to the previous Menu and exit from the Setup Mode

VOICING Push-button with indicator, selects between six different equalization variations

STANDBY/ON Push-button with indicator, switches the MEN220 ON or OFF (Standby) and resets the microprocessors

How to Operate the Setup Mode

The McIntosh MEN220 has been factory configured for default settings allowing for very basic operation. To benefit from all the MEN220 capabilities including Room Correction and the Electronic Crossover, it will require using the MEN220 Setup Mode and going through the options and functions. This is performed using the Front Panel Information Display and supplied RoomPerfect Calibration Microphone.

- Notes:* 1. Assemble the supplied Microphone Holder/ Stand/Boom Adapter and connect the Microphone to the MEN220 Microphone Connector on the Rear Panel using the supplied cable.
 2. If the MEN220 is currently On, proceed to step 2.

When performing the following Setup Instructions please refer to the MEN220 Setup Menu Diagram located on the separate folded sheet “Mc3B” for an overall view of the menu structure.

1. Press the STANDBY/ON Push-button on the Front Panel or press the  (Power) Push-button on the Remote Control to switch On the MEN220. The Front Panel Information Display top line will indicate “RoomPerfect: Muted” for approximately two seconds after turn on. Refer to figure 9. The



Figure 9

Front Panel will then indicate the previous operation settings for RoomPerfect and Voicing. Refer to figure 10.



Figure 10

2. Press the MENU Push-button to enter the Setup Mode. Refer to figure 11.



Figure 11



3. Rotate the NAVIGATE Control one detent position at a time or use the directional   Push-buttons on the Remote Control to view the main Setup Menu Modes (Input Settings, Output Settings, RoomPerfect, Advanced Settings and Exit Menu). Refer to figures 12, 13, 14, and 15.



Figure 12



Figure 13



Figure 14



Figure 15

4. To exit from the Setup Mode, press the MENU Push-button and the Front Panel Display will revert back to its normal display. Refer to figure 10.

It is important to follow the sequence of the Setup Mode Adjustments starting on page 18, as some of these adjustments are interactive.

Default Settings

The Default Settings Chart below indicates the Function Name, Default Setting and the Page Number for additional information.

MEN220 Default Settings		
Function Name	Setting	Page no.
Input Connection	Unbalanced	18
System Connection	Preamp - Power Amp	18
Out 1 (Hi)	Full Range	19
Out 2 (Lo)	Full Range	19
High Pass Filter Type	Butterworth 1 ord	19-20
High Pass Frequency	300Hz	19-20
Low Pass Filter Type	Butterworth 1 ord	19-20
Low Pass Frequency	300Hz	19-20
Output 1 (Hi)	0.0dB	20
Output 2 (Lo)	0.0dB	20
Distance Units	Inches	21
L1	0"	21
R1	0"	21
L2	0"	21
R2	0"	21
Front Panel Sensor:	On	22
Display Intensity	100%	22
McIntosh MEN220	SW Version: _ _ _	22



Input Connections Settings

The MEN220 Input Setup allows for the selection of input connection type, Unbalanced or Balanced.

1. Press the MENU Push-button to enter the Setup Mode. Refer to figure 16.



MEN220 Setup Menu
Input Settings >

Figure 16

2. Press the SELECT Push-button and the “Input Settings, Input Connection” will appear on the Information Display. Refer to figure 17.



Input Settings
Input Connection >

Figure 17

3. Press the SELECT Push-button again and the “Input Connection, Unbalanced” will appear. Refer to figure 18.



Input Connection
Unbalanced

Figure 18

4. The MEN220 default Input Connection Type is the Unbalanced Inputs. To change to the Balanced Inputs rotate the ADJUST Control or use the Directional ▲ ▼ Push-buttons on the Remote Control to select the Balanced Inputs. Refer to figure 19.



Input Connection
Balanced

Figure 19

5. Press the SELECT Push-button to enter either choice.
6. Rotate the NAVIGATE Control one detent position at a time or use the Directional ◀ ▶ Push-buttons

on the Remote Control to select “Input Settings, System Connection”, or the “Exit Menu”. Refer to figures 20 and 21.



Input Settings
< System Connection

Figure 20



MEN220 Setup Menu
< Exit Menu

Figure 21

Proceed to “System Connections” or to exit from the Setup Mode, press the MENU Push-button and the Front Panel Display will revert back to its normal display. Refer to figure 10.

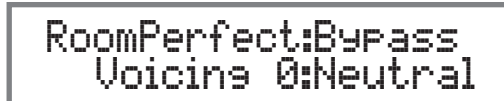

RoomPerfect:Bypass
Voicing 0:Neutral

Figure 10

System Connections Settings

Input Setup also allows for selecting how the MEN220 is connected into a system, either between the Preamplifier/Power Amplifier or in the Preamplifier Processor Loop.

1. Press the MENU Push-button to enter the Setup Mode. Refer to figure 16.
2. Press the SELECT Push-button and the “Input Settings, Input Connection” will appear on the Information Display. Refer to figure 17.
3. Rotate the NAVIGATE Control or use the Directional ◀ ▶ Push-buttons on the Remote Control to select “Input Settings, System Connection”. Refer to figure 20.

4. Press the SELECT Push-button and the “System Connection, Preamp - Power Amp” (the default setting) will appear. Refer to figure 22.



System Connection
Preamp - Power Amp

Figure 22

5. If the MEN220 is connected to the Processor Loop of the Preamplifier, rotate the ADJUST Control or use the Directional ▲ ▼ Push-buttons on the Remote Control to select the “System Connection, Processor Loop”. Refer to figure 23.



System Connection
Processor Loop

Figure 23

6. Press the SELECT Push-button to enter either choice.
7. Rotate the NAVIGATE Control one detent position at a time or use the Directional ◀ ▶ Push-buttons on the Remote Control to select “Input Settings, System Connection”, or the “Exit Menu”. Refer to figures 20 and 21.

Proceed to “Output Settings” or to exit from the Setup Mode, press the MENU Push-button and the Front Panel Display will revert back to its normal display. Refer to figure 10.

Output Settings

The MEN220 Output Settings include Crossover Options, Output Levels, Low and High Pass Filters and Delays Settings. The Low Pass and High Crossover Curves for both filter types (Butterworth and Linkwitz-Riley) are located on the separate folded sheet “Mc3A”.

INTRODUCTION TO CROSSOVERS:

Almost all Loudspeakers incorporate acoustic drivers and a passive crossover network. The passive crossover network channels the various audio frequencies to the appropriate acoustic driver taking into account the amplitude and phases of the audio signals the Loudspeaker reproduces. When an electronic crossover such as the MEN220 is used together with multiple Power Amplifiers and Loudspeakers, it is very important to maintain the correct amplitude and phases of the audio signals for accurate sound reproduction.

McIntosh’s Acoustics Laboratory has measured McIntosh Loudspeakers (with separate Low Frequency/High Frequency connections) when used with the MEN220 and has arrived at the optimum settings. There are two different settings. The first setting is for use with McIntosh Loudspeakers with a Low Frequency (Woofer) to High Frequency (Midrange/Tweeter) crossover frequency of 250Hz. The second setting is when the McIntosh Loudspeaker has a crossover of 80Hz. It is suggested to use these settings.

When the MEN220 is used with non-McIntosh Loudspeakers it is highly recommended to contact your Dealer for assistance. Your Dealer has the necessary measurement equipment and knowledge to properly set up the electronic crossover in the MEN220 for your Loudspeakers.

CROSSOVER OPTIONS:

1. Press the MENU Push-button to enter the Setup Mode. Refer to figure 16.
2. Rotate the NAVIGATE Control (or use the use the Directional ▲ ▼ Push-buttons on the Remote Control) to select “Output Settings”. Refer to figure 24.



MEN220 Setup Menu
< Output Settings >

Figure 24

3. Press the SELECT Push-button and the “Output Settings, Crossover Options” will appear. Refer to figure 25.



Output Settings
Crossover Options >

Figure 25

4. Press the SELECT Push-button and the default Crossover Setting will appear. There are four different Crossover Settings for Frequency Response Options; Full Range, High-Pass, Low-Pass and Lo-Pas (Low-Pass) Mono.

The MEN220 “Full Range” default setting for both Outputs 1 and Outputs 2 bypasses the built-in electronic crossover network circuitry. This sends the entire audio frequency range from 20Hz to 20,000Hz on to the Power Amplifier. Refer to figures 26, 27, and 28.



Out1(Hi):Full Range
Out2(Lo):Full Range

Figure 26



Out1(Hi):High-Pass
Out2(Lo):Low-Pass

Figure 27



Out1(Hi):Full Range
Out2(Lo):Lo-Pas Mono

Figure 28

The “High-Pass” setting allows all the frequencies above the crossover point to pass on to the Power Amplifier while at the same time reducing the amplitude of the frequencies below the crossover point. Refer to the separate sheet “Mc3A” Crossover Curves 4, 5 and 6.

The “Low-Pass” setting allows all the frequencies below the crossover point to pass on to the Power Amplifier while at the same time reducing the amplitude of the frequencies above the crossover point. Refer to the separate sheet “Mc3A” Crossover Curves 1, 2 and 3.

The “Lo-Pas (Low-Pass) Mono” setting is a variation of the Low-Pass setting and is designed to be used with a Subwoofer(s). It combines the Left and Right Channels together into a Mono Signal before the signal is processed by the MEN220 Crossover Circuitry. The crossover signal is available at the number 2 Outputs Left and Right.

HIGH AND LOW PASS FILTER SETTINGS:

In the following steps the Crossover Settings will be set up for a Bi-Amplified System using McIntosh Loudspeakers. If your Loudspeakers are not McIntosh contact your Dealer for assistance.

1. Press the MENU Push-button to enter the Setup Mode. Refer to figure 16.
2. Rotate the NAVIGATE Control (or use the Directional ▲ ▼ Push-buttons on the Remote Control) to select “Output Settings”. Refer to figure 24.
3. Press the SELECT Push-button and the “Output Settings, Crossover Options” will appear. Refer to figure 25.



Output Settings, con't

4. Press the SELECT Push-button and the default Crossover Setting will appear. Refer to figure 26.

```
Out1(Hi):Full Range
Out2(Lo):Full Range
```

Figure 26

5. Rotate the ADJUST Control (or use the Directional ▲ ▼ Push-buttons on the Remote Control) to select “Out1(Hi):High-Pass”. Refer to figure 27.

```
Out1(Hi):High-Pass
Out2(Lo):Low-Pass
```

Figure 27

6. Rotate the NAVIGATE Control (or use the directional ◀ ▶ Push-buttons on the Remote Control) to select “Out2(Hi):Full Range”. Then Rotate the ADJUST Control (or use the Directional ▲ ▼ Push-buttons on the Remote Control) to select “Out2(Lo):Low-Pass”. Refer to figure 27.

7. Press the SELECT Push-button and “Output Settings Crossover Options” will appear. Refer to figure 25 on page 19.

8. Rotate the NAVIGATE Control (or use the Directional ◀ ▶ Push-buttons on the Remote Control) to select “Output Settings, High Pass Filter”. Refer to figure 29.

```
Output Settings
< High Pass Filter >
```

Figure 29

9. Press the SELECT Push-button and the default Crossover Setting will appear. Refer to figure 30.

```
HighPass Filter Type
Butterworth 1 ord
```

Figure 30

10. Rotate the ADJUST Control (or use the Directional ▲ ▼ Push-buttons on the Remote Control) to select “HighPass Filter Type, LinkwitzRiley 4 ord”. Refer to figure 31.

```
HighPass Filter Type
LinkwitzRiley 4 ord
```

Figure 31

11. Press the SELECT Push-button and “High Pass Frequency, 300Hz” will appear. Refer to figure 32.

```
High Pass Frequency
300Hz
```

Figure 32

At this time refer the Loudspeaker Owner’s Manual Specification Page to determine if Low Frequency (Woofer) to High Frequency (Midrange/Tweeter) crossover frequency is 80Hz or 250Hz.

12. Rotate the ADJUST Control (or use the Directional ▲ ▼ Push-buttons on the Remote Control) to select “High Pass Frequency, 125Hz” when the Loudspeaker Crossover Frequency is 250Hz. Refer to figure 33A.

```
High Pass Frequency
125Hz
```

Figure 33A

If the Loudspeaker Crossover Frequency is 80Hz select “High Pass Frequency, 40Hz”. Refer to figure 33B.

```
High Pass Frequency
40Hz
```

Figure 33B

*Notes: 1. 125Hz is one-half times the Loudspeaker Low Frequency/High Frequency passive crossover point of 250Hz.
2. 40Hz is one-half times the Loudspeaker Low Frequency/High Frequency passive crossover point of 80Hz.*

11. Press the SELECT Push-button and figure 29 will appear.

12. Rotate the NAVIGATE Control (or use the Directional ◀ ▶ Push-buttons on the Remote Control) to select “Output Setting, Low Pass Filter”. Refer to figure 34.

```
Output Settings
< Low Pass Filter >
```

Figure 34

13. Press the SELECT Push-button and the default Crossover Setting will appear. Refer to figure 35.

```
LowPass Filter Type
Butterworth 1 ord
```

Figure 35

14. Rotate the ADJUST Control (or use the Directional ▲ ▼ Push-buttons on the Remote Control) to select “LowPass Filter Type, LinkwitzRiley 4 ord”. Refer to figure 36.

```
LowPass Filter Type
LinkwitzRiley 4 ord
```

Figure 36

15. Press the SELECT Push-button and “Low Pass Frequency, 300Hz” will appear. Refer to figure 37.

```
Low Pass Frequency
300Hz
```

Figure 37

16. Rotate the ADJUST Control (or use the Directional ▲ ▼ Push-buttons on the Remote Control) to select “Low Pass Frequency, 500Hz” when the Loudspeaker Crossover Frequency is 250Hz. Refer to figure 38A.



Figure 38A

If the Loudspeaker Crossover Frequency is 80Hz select “Low Pass Frequency, 160Hz”. Refer to figure 38B.



Figure 38B

*Notes: 1. 500Hz is two times the Loudspeaker Low Frequency/High Frequency passive crossover point of 250Hz.
2. 160Hz is two times the Loudspeaker Low Frequency/High Frequency passive crossover point of 80Hz.*

17. Press the SELECT Push-button followed by the MENU Push-button.
Proceed to “Output Levels” or to exit from the Setup Mode, press the MENU Push-button and the Front Panel Display will revert back to its normal display.

OUTPUT LEVELS:

1. Press the MENU Push-button to enter the Setup Mode. Refer to figure 16 on page 18.
2. Rotate the NAVIGATE Control (or use the Directional ▲ ▼ Push-buttons on the Remote Control) to select “Output Settings”. Refer to figure 24 on page 19.
3. Press the SELECT Push-button and the “Output

Settings, Crossover Options” will appear. Refer to figure 25 on page 19.

4. Rotate the NAVIGATE Control (or use the Directional ▲ ▼ Push-buttons on the Remote Control) to select “Output Settings, Output Levels”. Refer to figure 40.



Figure 40

5. Press the SELECT Push-button and the default Output Level Settings will appear. Refer to figure 41.



Figure 41

The MEN220 “Output Level” default setting for both Output 1 and Output 2 is 0.0dB, no change in volume between input and output. In some system component configurations it might be desirable to change the volume level going to the Power Amplifier connected to Output 1 versus the Power Amplifier connected to Output 2. The range of adjustment for both Output 1 and Output 2 is 0.0dB to -12.0dB with one tenth of a decible steps. To make changes in the Output Levels perform the following:

6. Select either Output 1 or 2 by using the NAVI-GATE Control (a flashing cursor will indicate which Output is selected). Refer to figure 42.

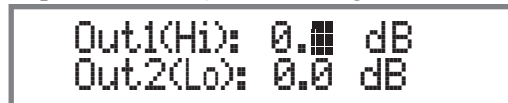

Figure 42

7. Rotate the ADJUST Control to reduce the Output volume to the desire level. Refer to figure 43.



Figure 43

DELAY SETTINGS:

1. Press the MENU Push-button to enter the Setup Mode. Refer to figure 16 on page 18.
2. Rotate the NAVIGATE Control (or use the Directional ▲ ▼ push-buttons on the Remote Control) to select “Output Settings”. Refer to figure 24 on page 19.
3. Press the SELECT Push-button and the “Output Settings, Crossover Options” will appear. Refer to figure 25 on page 19.
4. Rotate the NAVIGATE Control (or use the Directional ▲ ▼ Push-buttons on the Remote Control) to select “Output Settings, Delay Settings”. Refer to figure 44.

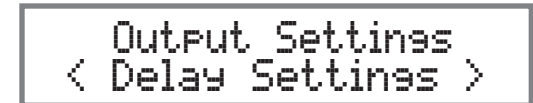

Figure 44

5. Press the SELECT Push-button and the default Delay Distance Units of “Inches” will appear. Refer to figure 45.



Figure 45

6. To change the distance measurement to “Centimeters” rotate the ADJUST Control. Refer to figure 46.



Figure 46

In the ideal audio system the Left and Right Loudspeakers would have the same measured distance to the Focus Listening Position. Due to room dimensions, furniture placements, etc. the distances may not be identical. The MEN220 can delay the sound coming from the closer Loudspeaker, assuring the sound arrives at the same time to the Focus Listening Position. Perform the following steps to correct for different distances:

7. First measure the actual distance from each Loudspeaker to the Focus Listening Position.
8. Press the SELECT Push-button, then rotate the NAVIGATE Control (or use the Directional ▲ ▼ Push-buttons on the Remote Control) to position the cursor and the ADJUST Control (or use the Directional ▲ ▼ Push-buttons on the Remote Control) to enter the distance (0-999) in inches or centimeters. Refer to figures 47, 48 and 49.



Figure 47



Figure 48



Figure 49

- Notes:*
1. L1 and R1 are for Loudspeaker connected to the Power Amplifier 1 (Power Amplifier 1 is connected to the MEN220 Output 1).
 2. L2 and R2 are for Loudspeakers connected to the Power Amplifier 2 (Power Amplifier 2 is connected to the MEN220 Output 2).
 3. When the MEN220 Electronic Crossover is configured for Low Pass Mono on Output 2 and two Subwoofers are connected, measure the distance to each Subwoofer. Then add together both distances and divide by two for the distance measurement for Output 2 (Mono).

Advanced Settings

The MEN220 Advanced Settings include Remote Control, Display, Software Version and Factory Reset.

REMOTE CONTROL:

1. Press the MENU Push-button to enter the Setup Mode. Refer to figure 16 on page 18.
2. Rotate the NAVIGATE Control (or use the Directional ▲ ▼ Push-buttons on the Remote Control) to select “Advanced Settings”. Refer to figure 50.



Figure 50

3. Press the SELECT Push-button and the “Advanced Settings, Remote Control” will appear. Refer to figure 51.



Figure 51

4. Press the SELECT Push-button and the default Remote Control Setting will appear. Refer to figure 52.



Figure 52

In a typical Audio/Video System, the MEN220 Power Control and Data Port Connections are made to the Audio Preamplifier or A/V Control Center. This allows the MEN220 to switch On or Off with the Audio Preamplifier or A/V Control Center. The commands coming from the Remote Control (supplied with the MEN220) are received by the Audio Preamplifier or A/V Control Center and are passed on to the MEN220. The MEN220 Front Panel Sensor needs to

be disabled to prevent possible interference. To deactivate the MEN220 Front Panel Sensor perform the following steps:

5. Rotate the ADJUST Control to switch Off the Front Panel Remote Control Sensor. Refer to figure 53.



Front Panel Sensor
Off

Figure 53

DISPLAY:

1. Press the MENU Push-button to enter the Setup Mode. Refer to figure 16 on page 18.
2. Rotate the NAVIGATE Control (or use the Directional ▲ ▼ Push-buttons on the Remote Control) to select “Advanced Settings”. Refer to figure 50.
3. Press the SELECT Push-button and the “Advanced Settings, Display” will appear. Refer to figure 54.

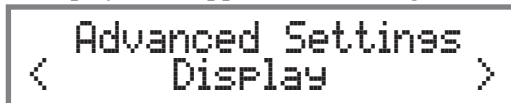

Advanced Settings
Display

Figure 54

The MEN220 Front Panel Information Display Intensity has four different settings 100% (default), 75%, 50% and 25%. To change from the default setting perform the following:

4. Press the SELECT Push-button and “Display Intensity, 100%” will appear. Refer to figure 55.

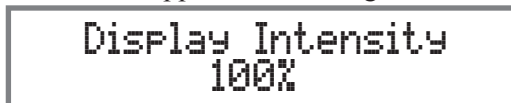

Display Intensity
100%

Figure 55

5. Rotate the ADJUST Control to select the desired Display Intensity. Refer to figure 56.



Display Intensity
50%

Figure 56

SOFTWARE VERSION:

1. Press the MENU Push-button to enter the Setup Mode. Refer to figure 16 on page 18.
2. Rotate the NAVIGATE Control (or use the Directional ▲ ▼ Push-buttons on the Remote Control) to select “Advanced Settings”. Refer to figure 50.
3. Press the SELECT Push-button and the “Advanced Settings, Software Version” will appear. Refer to figure 57.



Advanced Settings
Software Version

Figure 57

4. Press the SELECT Push-button and the “McIntosh SW Version: _ _ _” will appear. Refer to figure 58.



McIntosh MEN220
SW Version: - - -

Figure 58

FACTORY RESET:

1. Press the MENU Push-button to enter the Setup Mode. Refer to figure 16 on page 18.
2. Rotate the NAVIGATE Control (or use the Directional ▲ ▼ Push-buttons on the Remote Control) to select “Advanced Settings”. Refer to figure 50.
3. Press the SELECT Push-button and the “Advanced Settings, Remote Control” will appear. Rotate the NAVIGATE Control (or use the Directional ▲ ▼ Push-buttons on the Remote Control) to select “Factory Reset”. Refer to figure 59.



Advanced Settings
Factory Reset

Figure 59

4. Press the SELECT Push-button and the “Delete All Settings?, No” will appear. Refer to figure 60.

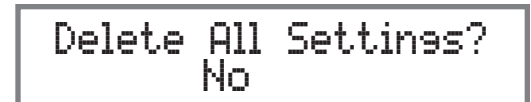

Delete All Settings?
No

Figure 60

5. Rotate the NAVIGATE Control (or use the Directional ▲ ▼ Push-buttons on the Remote Control) to select “Delete All Settings?, Yes”. Refer to figure 61.



Delete All Settings?
Yes

Figure 61

6. Press the SELECT Push-button and figure 59 will appear briefly. The MEN220 will switch Off.
7. Press the STANDBY/ON Push-button on the Front Panel or press the ⏻ (Power) Push-button on the Remote Control to switch On the MEN220.

RoomPerfect

The RoomPerfect Measure and Adjustment Process takes acoustic measurements in the listening room and then applies corrections for achieving the best possible results. The Focus Position (location in the room) is typically where one would be during serious listening. Measurements will also be taken in additional room locations for a more complete analysis of your listening room acoustics.

Notes: 1. Set the tone/equalizer controls on the Preamplifier to the flat setting position, the balance control to the 12 O'clock position and the volume control to the normal listening volume level.

2. *Make sure the MEN220 Voicing is set to "Neutral" (as indicated on the Front Panel Display) before proceeding. Refer to page 28 for additional information.*
 3. *It might be advisable to temporarily switch off the room/house heating/cooling system while the Room Perfect measurement process is occurring. If there are open windows, they should be closed. All of these steps will allow lower testing volume levels and more accurate measurements.*
 4. *If the MEN220 is already in the Setup Mode proceed to step 2.*
 5. *The MEN220 Front Panel Display Illustrations in this RoomPerfect Setup Section of the Owner's Manual are from actual room measurements. The information displayed on your MEN220 may be different to reflect the difference in room acoustics.*
1. Press the MENU Push-button to enter the Setup Mode.
 2. Rotate the NAVIGATE Control (or use the Directional ◀ ▶ Push-buttons on the Remote Control) to select "MEN220 Setup Menu, RoomPerfect". Refer to figure 70.

MEN220 Setup Menu
◀ RoomPerfect ▶

Figure 70

4. Press the SELECT Push-button and the "RoomPerfect Guided Setup" will appear. Refer to figure 71.

RoomPerfect
Guided Setup

Figure 71

5. Press the SELECT Push-button and the "Place microphone in first focus position" will appear. Refer to figure 72. At this time place the microphone in the focus location with the front of the microphone

Place microphone in
first focus position

Figure 72

pointing towards the loudspeakers (center location between the Left and Right Loudspeakers). The height of the microphone should be at ear level.

Note: The Microphone Stand Boom Adaptor allows the microphone to be placed over objects such as a chair or table.

6. Press the SELECT Push-button and the "Volume Calibration measuring" will appear. Refer to figure 73. The MEN220 will send out to the loudspeakers a test tone to obtain a measurement level

Volume Calibration
measuring

Figure 73

about 20dBs above the background noise level in your room. Several minutes after testing started the MEN220 might indicate the need for a louder

or quieter test level. Refer to figures 74 and 75.

Adjust level: 17 Up
Retry Save Current

Figure 74

Adjust level: 3Down
Retry Save Current

Figure 75

Rotate the MEN220 ADJUST Control clockwise if figure 74 appears or counterclockwise if figure 75 appears.

7. Press the SELECT Push-button and the "Volume Calibration measuring" will appear again. Refer to figure 73. When the correct Volume Test Level has been achieved figure 76 will appear. Then press

Ready - Press select
to start measurement

Figure 76

the SELECT Push-button and the MEN220 will start measuring the Focus Position and figure 77 will appear.

Measuring first
Focus position. . .

Figure 77

Note: If the requested test volume level is already too loud as to be uncomfortable to your ears and figure 74 appears, rotate the NAVIGATE Control (or use the Directional ◀ ▶ Push-buttons on the Remote Control) to select "Save Current". Then press the SELECT Push-button. The MEN220 will then test at the previous lower volume setting.

8. When figure 78 appears relocate the microphone



Figure 78

to another place in the listening room and point it in a different direction. Then press the SELECT Push-button. Refer to figure 79.



Figure 79

Note: When the microphone is relocated to additional room locations, it is advisable to place it randomly at various heights off the floor and pointed in different directions. It is also advisable the positions be at least 2 feet (60.69cm) from previous measurement locations and from the Loudspeakers; and never behind the Loudspeakers.

9. After Room Position No. 1 has been measured, the Front Panel Information Display will indicate the computed Room Knowledge similar to figure 80.



Figure 80

Press the SELECT Push-button and figure 81 will

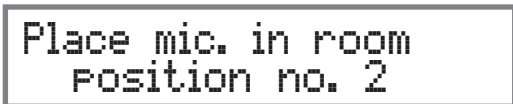

Figure 81

appear. Place the microphone in another room location, then press the SELECT Push-button. Refer to figure 82.



Figure 82

10. After measuring room location 2 the Front panel Display indication might be similar to figure 83.

Note: Once RoomPerfect has achieved a Room



Figure 83

Knowledge score of 90% or above, it will ask if you want to make additional measurements. Additional measurements will make improvements, however it might take many more measurements to achieve the higher Room Knowledge score.

11. If you want to achieve a reading closer to 100%, select Yes and continue placing the Microphone in the third room location and proceed. If No was selected figure 84 will appear.



Figure 84

When the MEN220 has finished calculating and applying filters to the audio signal path, the Front Panel Display will once again briefly indicate “RoomPerfect Guided Setup” and then indicate “RoomPerfect:Focus 1, Voicing 0:Neutral. Refer to figure 85.



Figure 85

ADDITIONAL FOCUS POSITIONS:

The MEN220 allows for measurement and storage of seven additional Focus Positions. To add additional Focus Positions at this time proceed to step 11. If no additional measurements are to be taken at this time proceed to “How to Operate the MEN220” starting on page 28.

11. Perform steps 1 thru 4.

12. Rotate the NAVIGATE Control (or use the directional ◀ ▶ Push-buttons on the Remote Control) to select “RoomPerfect, Add Focus Position”. Refer to figure 86.



Figure 86

13. Press the SELECT Push-button and the “Place microphone in new focus position” will appear. Refer to figure 87.



Figure 87

14. Press the SELECT Push-button and the “Measuring new Focus position...” will appear. Refer to figure 88.



Figure 88

15. When the measurements are completed “Save as Focus pos.: (2-8) 2” will appear. Refer to figure 89.



Figure 89

RoomPerfect, con't

The MEN220 will automatically assign the next available focus position number to the just completed measurement. If you would like to assign a different focus position number rotate the ADJUST Control to select a different number.

16. Press the SELECT Push-button to save the Focus Position and “Calculating Filters, Please wait”.

Refer to figure 84 on page 25.

If you would like to add additional Focus Positions at this time repeat steps 11 thru 16 . The MEN220 will exit the RoomPerfect Setup Mode in several minutes. To exit sooner press the MENU Push-button until the Front Panel Display indicates the Focus 2 (or higher) is active.

ADDITIONAL MEASUREMENTS:

The MEN220 allows for additional room measurements to be added to the initial RoomPerfect measurements. These additional measurements will increase the percentage of Room Knowledge and potentially improve the sound quality from the initial correction.

17. Perform steps 1 thru 4 on page 24.

18. Rotate the NAVIGATE Control or use the Directional ◀ ▶ Push-buttons on the Remote Control to select “RoomPerfect, Add Room Measurement”. Refer to figure 90.

Figure 90

19. Press the SELECT Push-button and the “Place mic. in room position no. 4” will appear. Refer to figure 91.

Figure 91

20. Press the SELECT Push-button and the “Measuring room position.no. 4” will appear. Refer to figure 92.

Figure 92

The MEN220 will add the new measurement to the previous measurements and recalculate for the best room response.

ROOMPERFECT STATUS:

After the initial measurements have been taken the results can be recalled at any time by performing the following steps:

21. Perform steps 1 thru 4 on page 24.

22. Rotate the NAVIGATE Control (or use the Directional ◀ ▶ Push-buttons on the Remote Control) to select “RoomPerfect, Status”. Refer to figure 93.

Figure 93

23. Press the SELECT Push-button and the “3 Room Measurements Room Knowledge: 95% ”will appear. Refer to figure 94.

Figure 94

24. Rotate the ADJUST Control (or use the Directional ▲ ▼ Push-buttons on the Remote Control) to select “Focus 1, Room Corrections: 11%”. Refer to figure 95.

Figure 95

Note: The RoomPerfect Room Correction Percentage is an indication of the degree of acoustic problems measured and corrected. This includes room acoustics and Loudspeaker placement in the room. The Correction Percentage is not an indication of performance of the MEN220 or Loudspeaker.

RP BYPASS GAIN:

There may be a difference in overall volume levels when comparing the RoomPerfect Focus or Global Modes and the Bypass Mode. The RoomPerfect (RP) Bypass Gain adjustment allows trimming the Bypass Mode overall volume level by performing the following steps:

25. Perform steps 1 thru 4 on page 24.

26. Rotate the NAVIGATE Control (or use the Directional ◀ ▶ Push-buttons on the Remote Control) to select “RoomPerfect, RP Bypass Gain”. Refer to figure 96.

Figure 96

27. Press the SELECT Push-button and the “RP Bypass Gain , 0.0dB”will appear. Refer to figure 97.

Figure 97

Select either the Global or Focus Mode by pressing the appropriate push-button on the Front Panel or Remote Control. Establish a suitable volume level while listening to music with a wide range of musical instruments. Then select the Bypass Mode and rotate the ADJUST Control (or use the Directional ▲ ▼ Push-buttons on the Remote Control) to closely match the volume level of the Global or Focus Modes.

28. Proceed to “How to Operate the MEN220” starting on page 28.





How to Operate

The MEN220 has built in the ability to improve the sound quality of your Audio System. However, it does require the RoomPerfect portion of the Setup Mode be performed in order to benefit from the potential improvements. Please refer to “How to Operate the Setup Mode” on page 17 and “RoomPerfect” starting on page 24.

Power On

Press the STANDBY/ON Push-button on the Front Panel or the  (Power) Push-button on the Remote Control. Refer to figures 101 and 113. The MEN220 will go through a brief startup initialization with the Front Panel Information Display indicating the audio is muted. Refer to figure 113.



Figure 100

The Front Panel Information Display will then indicate the current RoomPerfect Focus selection (Focus 1 thru Focus 8) or “Bypass” if the RoomPerfect Mode has been switched Off. Refer to figures 102 and 103.



Figure 102



Figure 103

Global Mode

Press the GLOBAL MODE Push-button to activate the RoomPerfect Global Setting. Refer to figure 104.



Figure 104

The Global Setting is a combination room performance measurements including Focus and additional locations in the room. Use the Global Mode when the listening will be performed in a variety of different locations or when more than one person will be listening in the room at the same time.

Focus Mode

Press the FOCUS MODE Push-button to activate the RoomPerfect Focus Setting. Refer to figure 102. Continued presses of the FOCUS MODE Push-button will allow selection of seven possible additional room measurement Focus locations which were performed during the RoomPerfect Setup. Refer to figure 103.



Figure 103

Bypass Mode

Press the BYPASS MODE Push-button to deactivate the RoomPerfect Room Corrections. This includes both the Focus and Global settings.

Menu

Press the MENU Push-button to enter the Setup Mode. Refer to figure 104 and to MEN220 Setup Section of this Owner’s Manual starting on page 17.



Figure 104

The MENU Push-button may also be used for returning to the previous menu and repeated presses will exit out of the Setup Mode.

Voicing

Press the VOICING Push-button to select one of 7 different preset equalization curves for altering the sound of the program material and/or your listening mood. Refer to figures 105 thru 112. Also refer to the Equalization Curves for all the presets that are located on the separate folded sheet “Mc3A”.

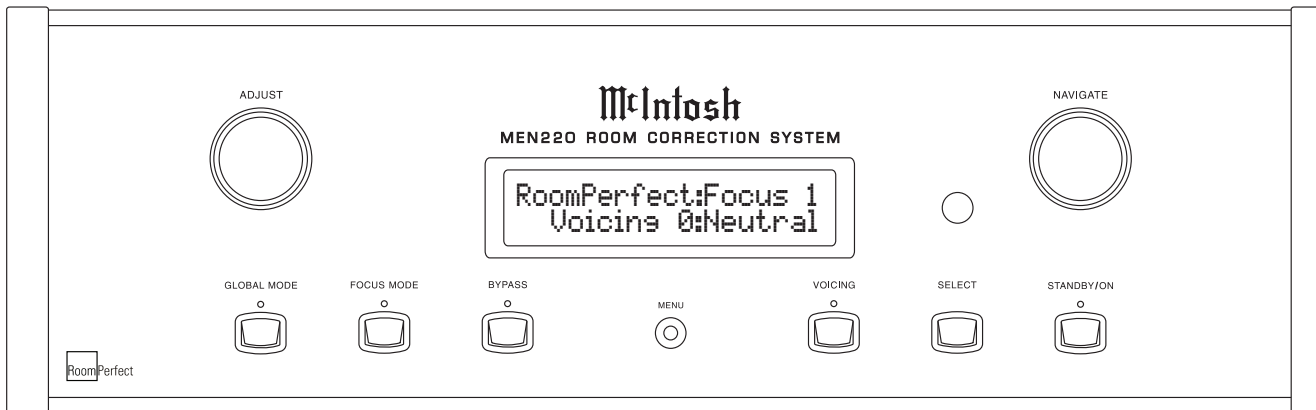

Figure 101

RoomPerfect:Focus 1
Voicing 3: Mellow

Figure 105

New Voicing:
0: Neutral

Figure 106

New Voicing:
1: Music1

Figure 107

New Voicing:
2: Music2

Figure 108

New Voicing:
3: Mellow

Figure 109

New Voicing:
4: Soft

Figure 110

New Voicing:
5: Party

Figure 111

New Voicing:
6: Loudness

Figure 112

Select

The SELECT Push-button is used to select various options when in the Setup Mode together with the ADJUST Control, NAVIGATE Control and MENU Push-button.

Reset of Microprocessors

In the unlikely event the controls of the MEN220 stop functioning, the microprocessors can be reset by removing AC Power from the MEN220 for several minutes. This can be accomplished by disconnecting the AC Power cord from the Rear Panel of MEN220 or removing the “Plug” end of the MEN220 AC Power Cord from the AC Outlet.



Figure 113

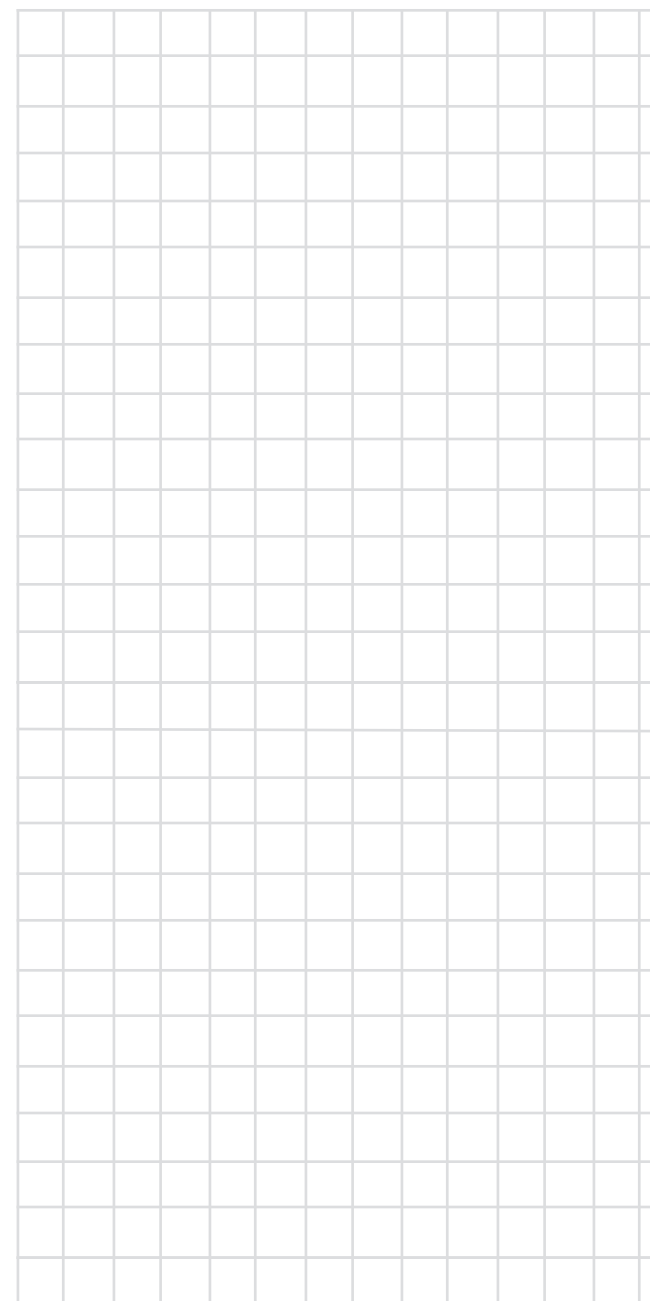

Audio Specifications

Unless otherwise noted, the below MEN220 Specifications were taken with RoomPerfect set to Bypass Mode and Voicing Mode set to Neutral.

Frequency Response

+0, -0.5dB from 20Hz to 20,000Hz

Total Harmonic Distortion

0.002% from 20Hz to 20,000Hz

Maximum Input Voltage

4.5V Unbalanced and Balanced (Preamp-Power Amp)

2.25V Unbalanced and Balanced (Processor Loop)

Maximum Output Voltage

4.5V Unbalanced and Balanced (Preamp-Power Amp)

2.25V Unbalanced and Balanced (Processor Loop)

Signal To Noise Ratio (A-Weighted)

100dB

Input Impedance

10K ohms Unbalanced and Balanced

Voltage Gain

0dB

Output Impedance

50 ohms

Crossover Filter Types, Order and Slope

Butterworth, 1st order, 6 dB/octave

Butterworth, 2nd order, 12 dB/octave

Butterworth, 4th order, 24 dB/octave

Linkwitz-Riley, 2nd order, 12 dB/octave

Linkwitz-Riley, 4th order, 24 dB/octave

Linkwitz-Riley, 8th order, 48 dB/octave

Measurement Microphone

Omnidirectional Electret Condenser Microphone

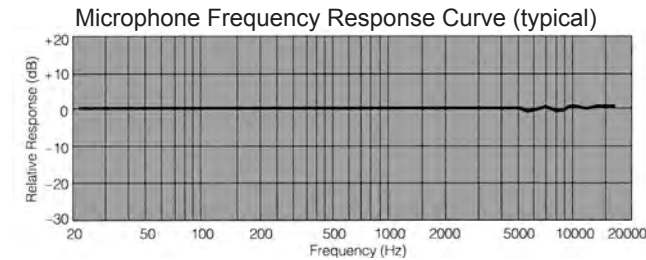
General Specifications
Power Requirements

100V ~ 50/60Hz at 35 watts

110V ~ 50/60Hz at 35 watts

120V ~ 50/60Hz at 35 watts

220V ~ 50/60Hz at 35 watts

230V ~ 50/60Hz at 35 watts

240V ~ 50/60Hz at 35 watts

Standby, less than 1 watt

Note: Refer to the rear panel of the MEN220 for the correct voltage.

Overall Dimensions

Width is 17-1/2 inches (44.45cm)

Height is 6 inches (15.24cm) including feet

Depth is 18 inches (45.72cm) including the Front Panel, Knobs and Cables

Weight

25.5 pounds (11.6 kg) net, 41.9 pounds (19.0 kg) in shipping carton

Shipping Carton Dimensions

Width is 26-1/2 inches (67.3cm)

Depth is 24-1/4 inches (62.2cm)

Height is 11-3/4 inches (29.9cm)

Packing Instructions

In the event it is necessary to repack the equipment for shipment, the equipment must be packed exactly as shown below. It is very important that the four plastic feet are attached to the bottom of the equipment. This will ensure the proper equipment location on the bottom pad. Failure to do this will result in shipping damage.

Use the original shipping carton and interior parts only if they are all in good serviceable condition. If a shipping carton or any of the interior part(s) are needed, please call or write Customer Service Department of McIntosh Laboratory. Refer to page 4. Please see the Part List for the correct part numbers.

Quantity	Part Number	Description
1	034492	Shipping carton only
4	033837	End cap
1	033836	Inside carton only
1	033725	Inner carton top pad
1	034301	Bottom pad
2	034446	Foam plug
4	017937	Plastic foot
4	400159	#10-32 x 3/4" screw
4	404080	#10 Flat washer
1	034499	Accessory Box
1	034500	Slotted foam
1	034501	Divider foam

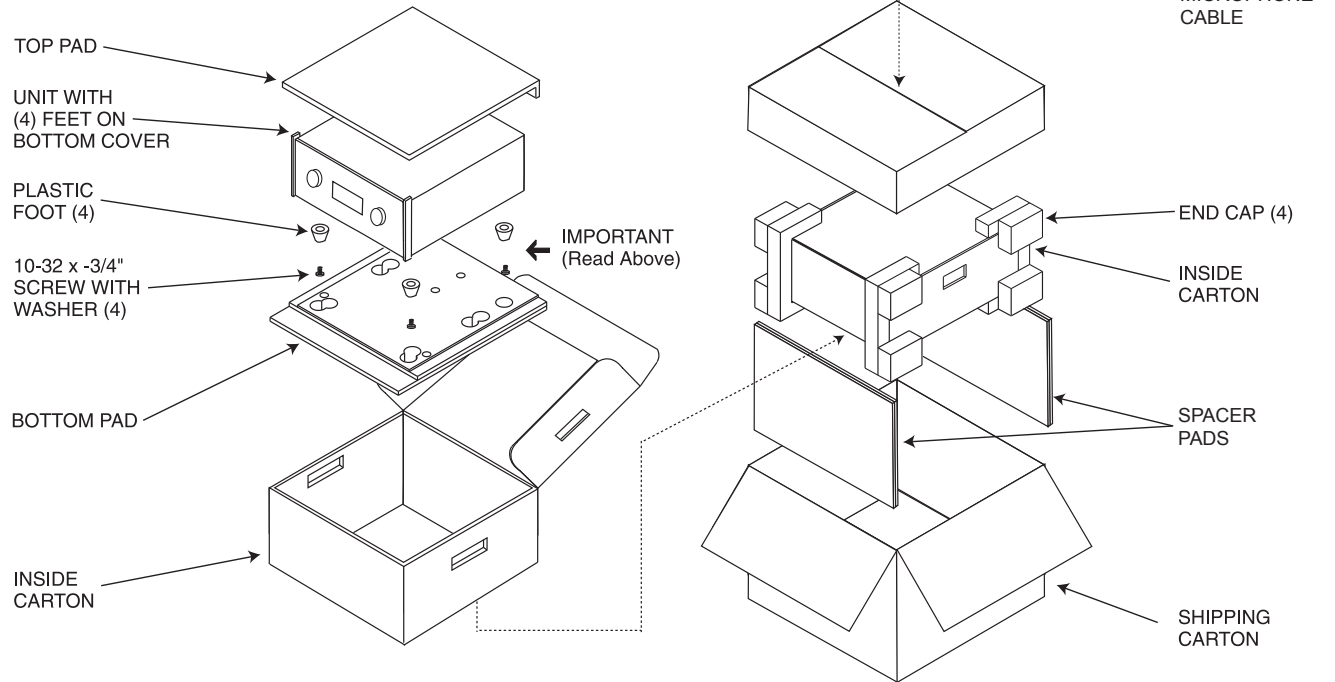



McIntosh Laboratory, Inc.
2 Chambers Street
Binghamton, NY 13903
www.mcintoshlabs.com

The continuous improvement of its products is the policy of McIntosh Laboratory Incorporated who reserve the right to improve design without notice.
Printed in the U.S.A.